

## Statement

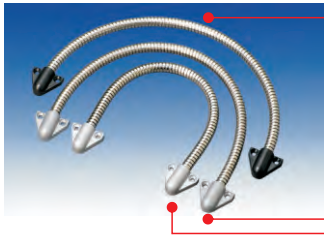

The Door Loops are wire extension protectors that you install on doorframe. It gives attractive and neat result for the wiring; the length of DL-350 and DL-200 metal hose is 40 cm respectively.



DL-200-1  
DL-200-6  
DL-200-8  
Length: 40cm  
Triangle plastic sleeve  
Surface mount

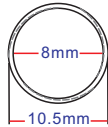

DL-200W  
Length: 40cm  
Triangle plastic sleeve  
Surface mount

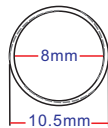

DL-350  
Length: 40cm  
Square aluminum sleeve  
Surface mount

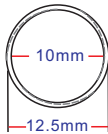

DL-350-SP  
Length: 40cm  
Square aluminum sleeve  
Surface mount

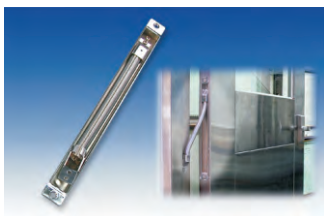

DL-400  
Length: 29cm  
Mortise mount

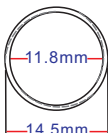

## Dimensions

DL-200

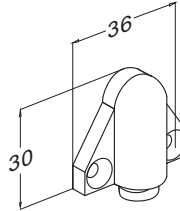

DL-350

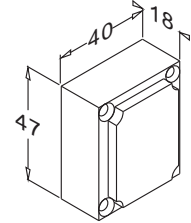

DL-400

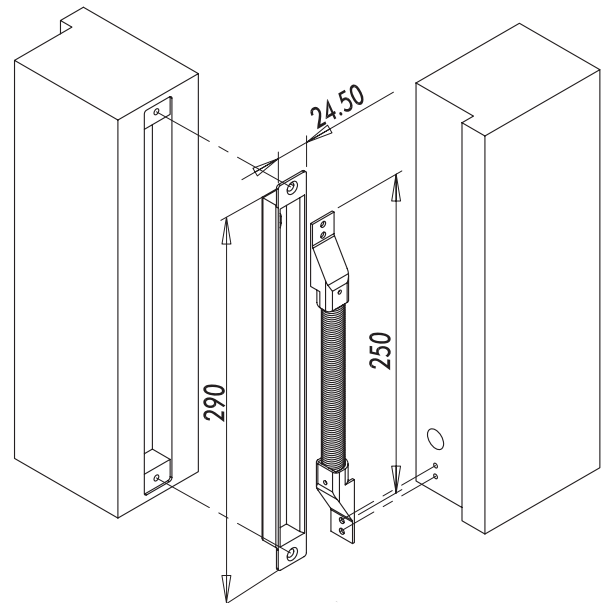

Unit: mm

## Application



DL-200, DL-350

## Warranty

The product is warranted against defects in material and workmanship while used in normal service for a period of 1 year from the date of sale to the original client. The GEM policy is one of continual development and improvement; therefore GEM reserves the right to change specifications without notice.

The DL350 and DL400 door loops are designed to protect the lock release cable when running across a door or frame and installed as per illustrations below



DL-350

Surface mount door loop



The Door Loops are wire extension protectors when you install on the door frame to the door. It gives an attractive and neat result for the wiring; DL-350 are metal hose and length is 400mm



DL-400

Flush mount door loop



Doorentryonline Ltd