

Villa application

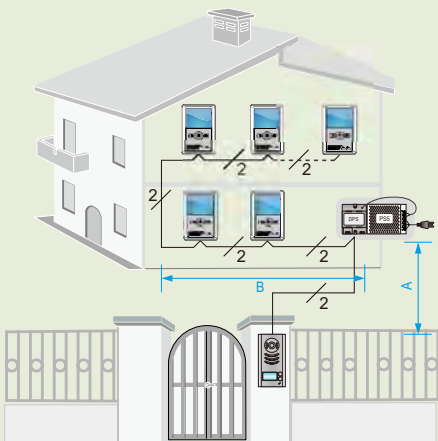

Cable and Distance

Cable	A(m)	B(m) ≤2 VT25	B(m) ≤16 VT25
CAT5 Cable (Combined)	40	80	—
Pair Cable (Parallel) 2X0.75 mm ²	30	50	—
Twisted Cable 2X0.75 mm ²	60	100	40
Twisted Cable 2X1.0 mm ²	80	120	60

Extending Monitors(up to 16)

In-Out topology:

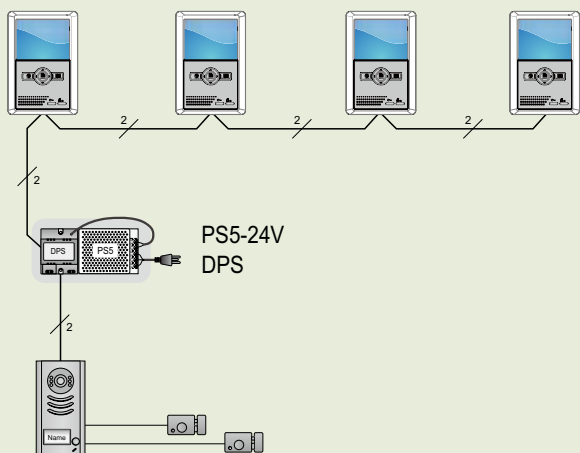

Star topology:

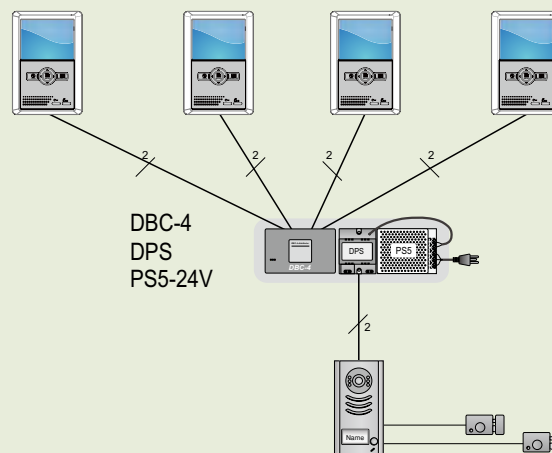

Extending Door/CCTV Cameras

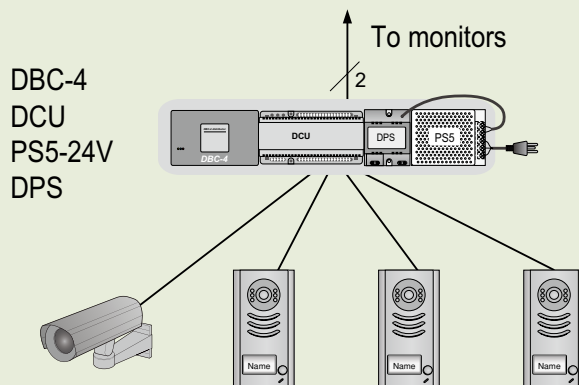
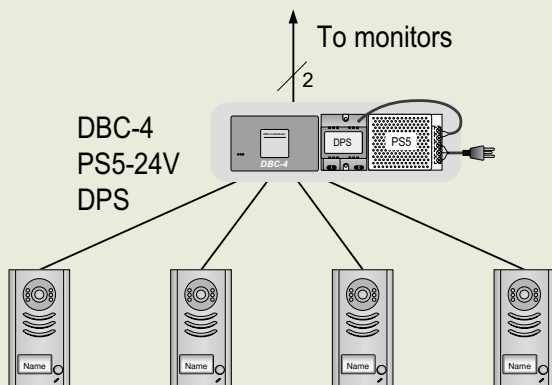

2-Wire Video System

596(F)/ID User Manual

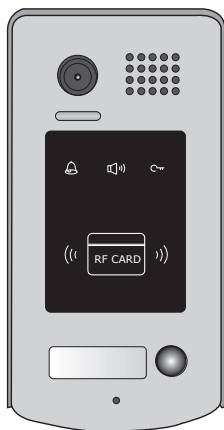

596/ID



596F/ID

1.Parts and Functions

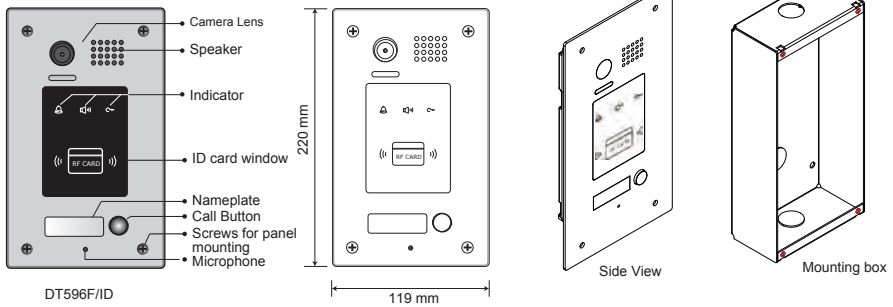
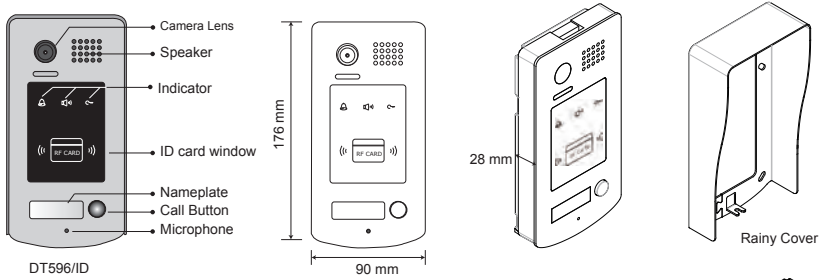

2.Terminal Descriptions

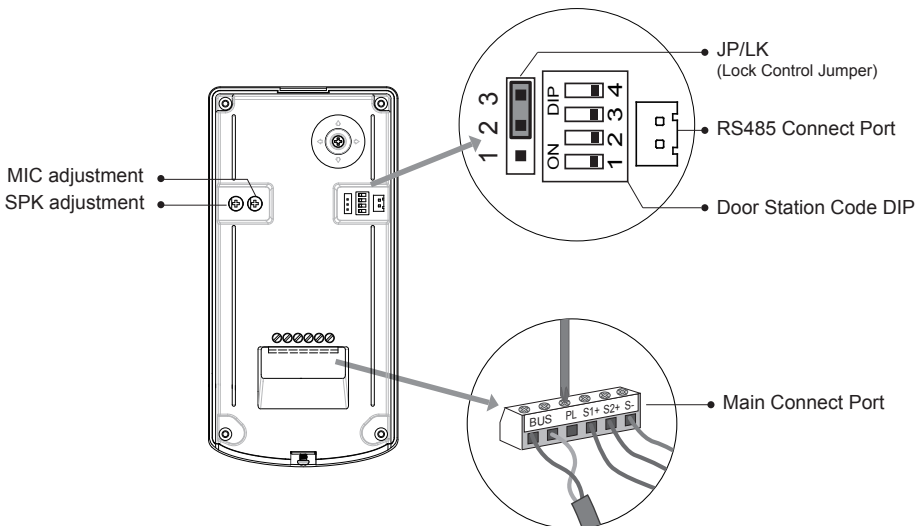

- **JP/LK(Lock Control Jumper):** To select the lock type: see section 4
- **Doorstation Code DIP:** Total 4 door stations can be supported, see section 5
- **RS485:** Used to update the program for door station
- **MIC:** Adjust the volume of Microphone
- **SPK:** Adjust the volume of Speaker
- **Main Connect Port:** To connect the bus line and the electronic locks.
- **BUS:** Connect to the bus line, no polarity.
- **PL:** External lock power input, connect to the power positive(power +).
- **S1+, S2+:** Lock power(+) output, to connect 2 locks.
- **S-:** Lock power(-) output, connect to the power(-) input of locks(only when using the camera to power the locks, if using the external power supply for the locks, the S- will not be connected).

3. Door Station Mounting

DT596/ID Mounting

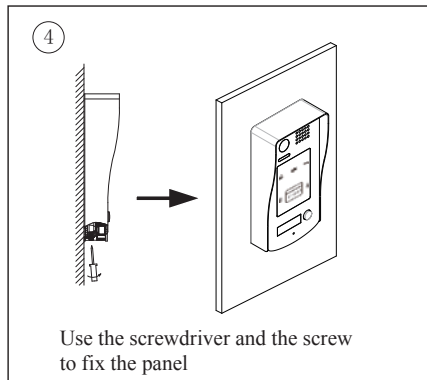
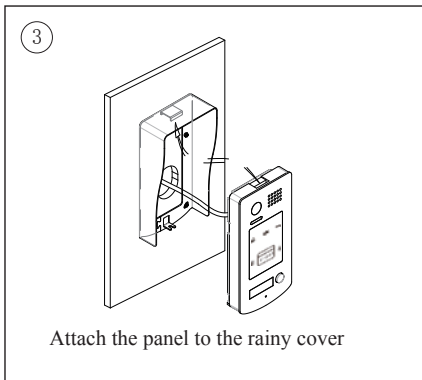
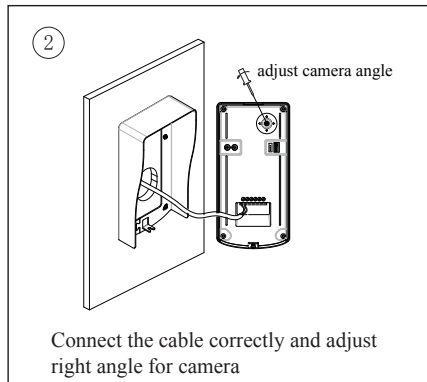
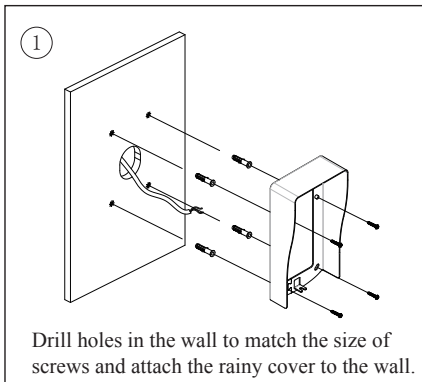

DT596F/ID Mounting

①

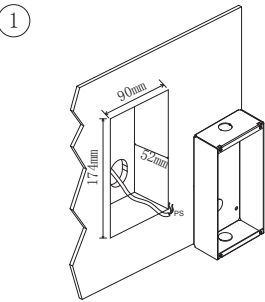

Drill a hole in the wall to match the size of the mounting box and attach to the wall.

②

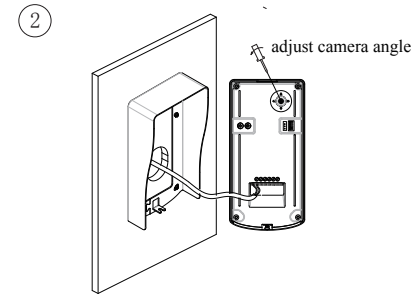

Connect the cable correctly and adjust right angle for camera

③

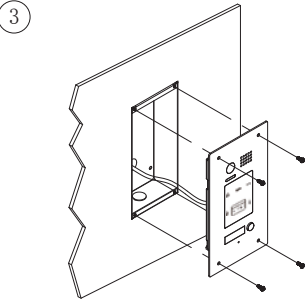

Attach the panel to the mounting box and use screws supplied to fix the panel

④

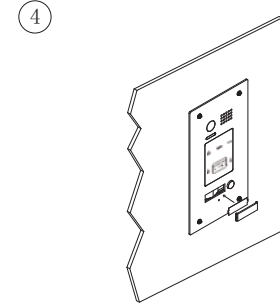

Place name label

Adjusting Camera Angle

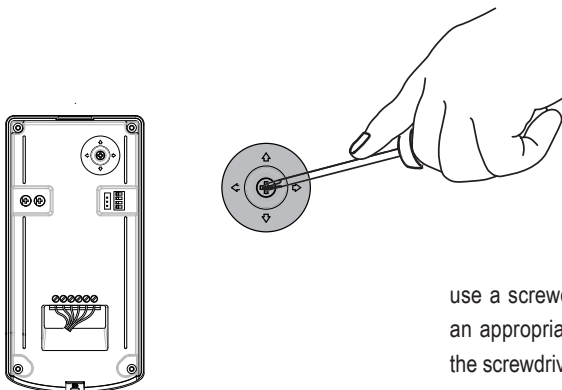

use a screwdriver to loosen the screw, then adjust an appropriate camera angle, after finishing, use the screwdriver to fix the screw.

Placing Name Label

Press the plastic cover on right/left side to move away the cover,insert a name paper,then put the plastic cover back to the panel.

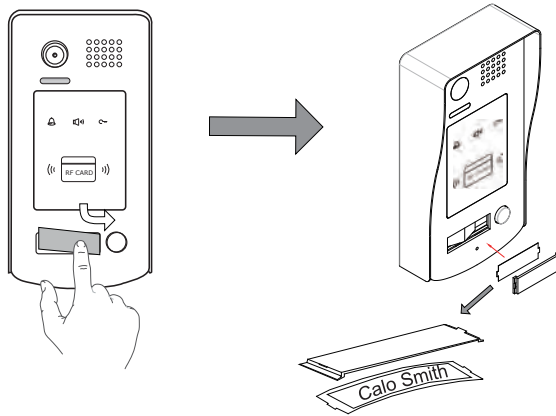

4. System Wiring and Electric Lock Connection

Basic Connection

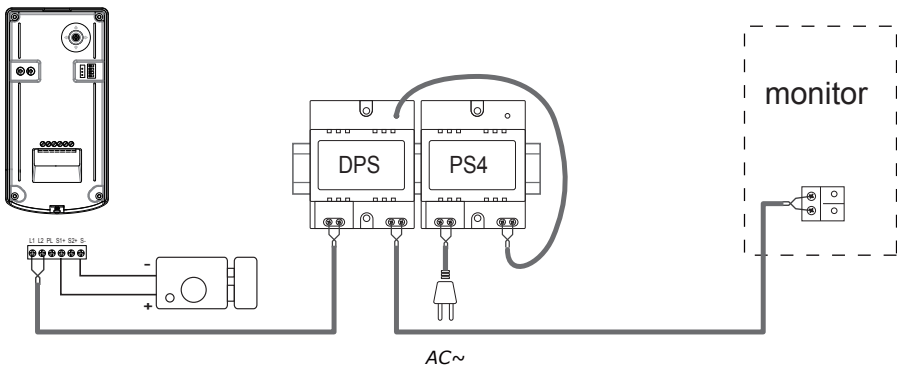

Connecting to a standard lock release

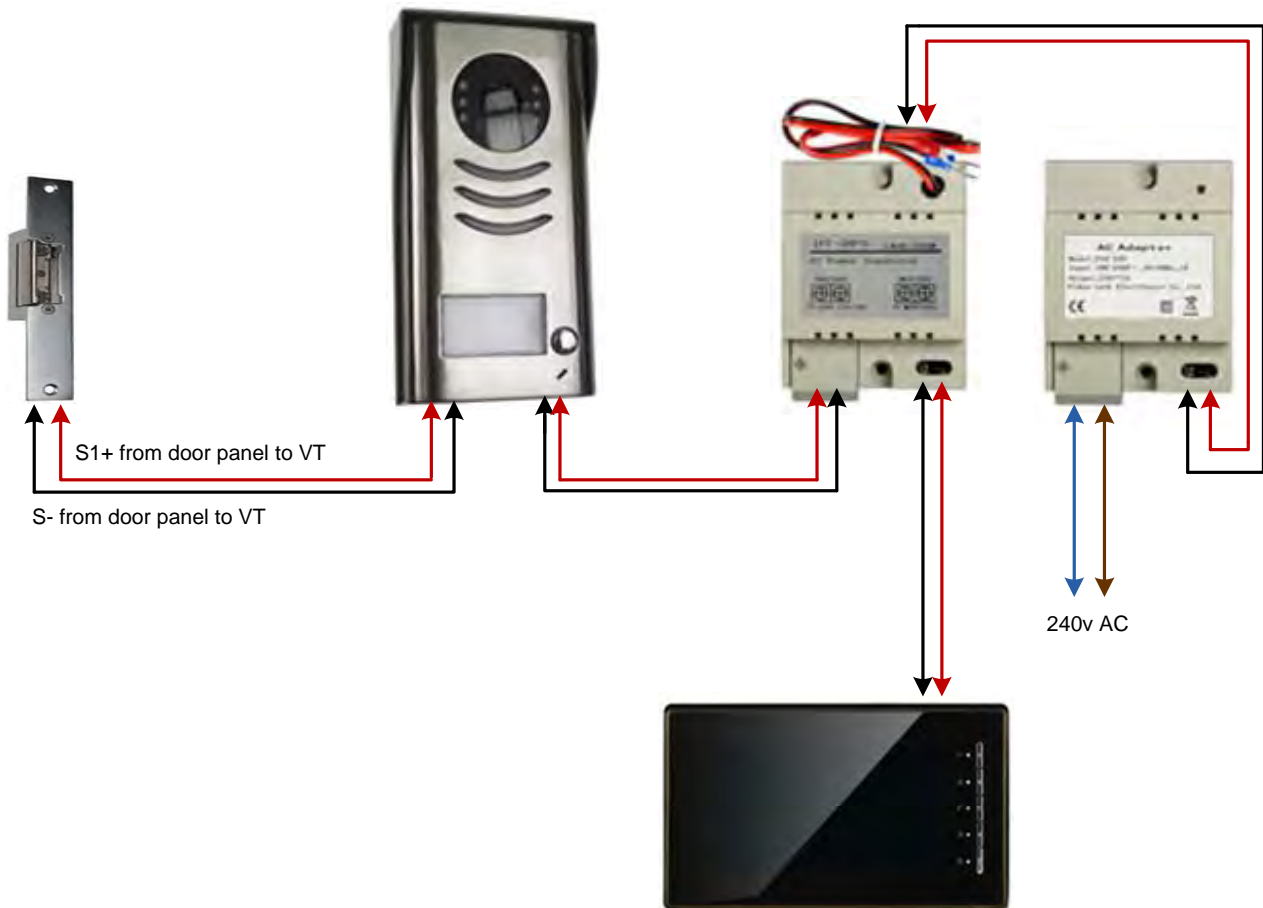

Connecting to a magnetic lock

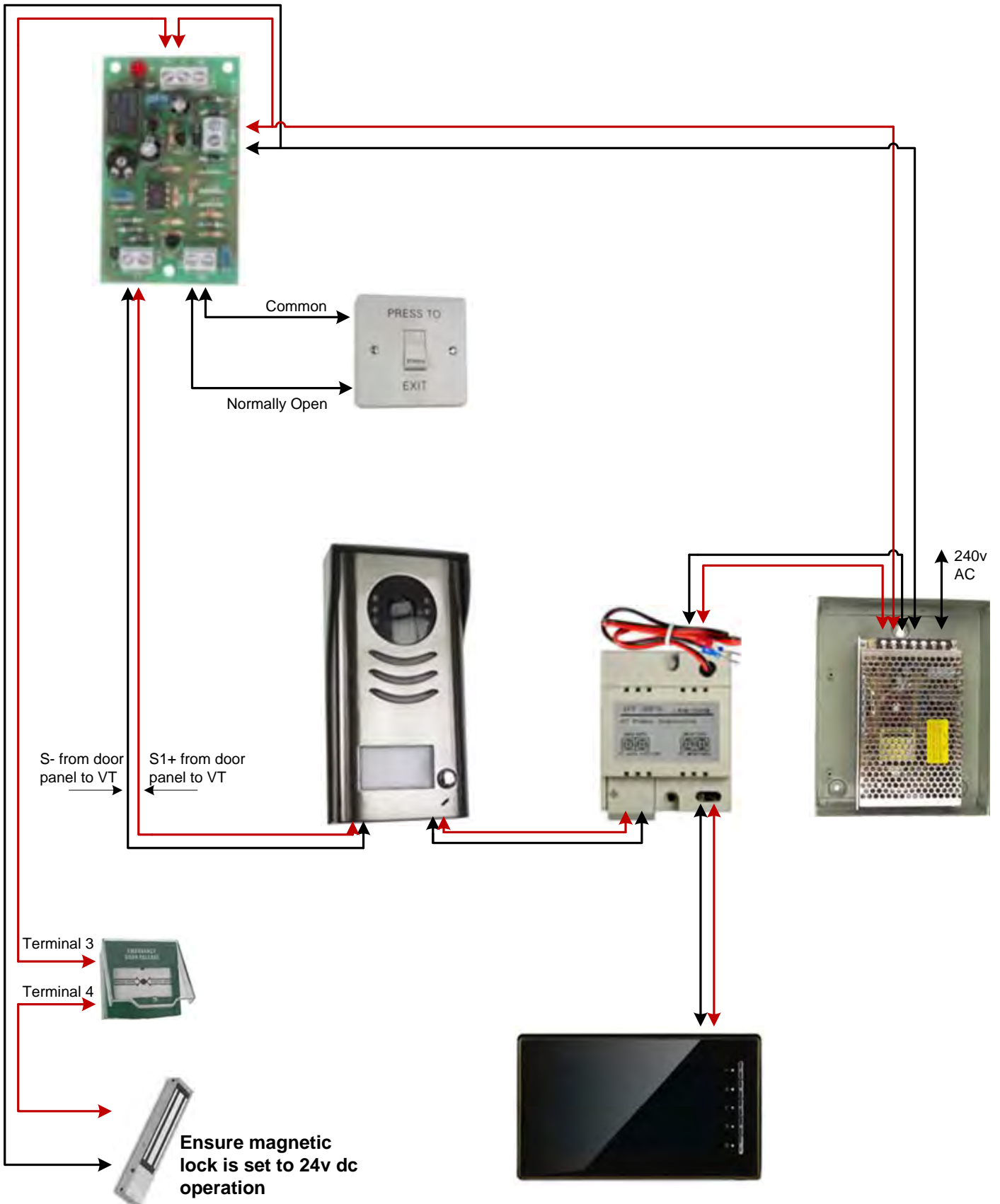

Connecting to an automated gate

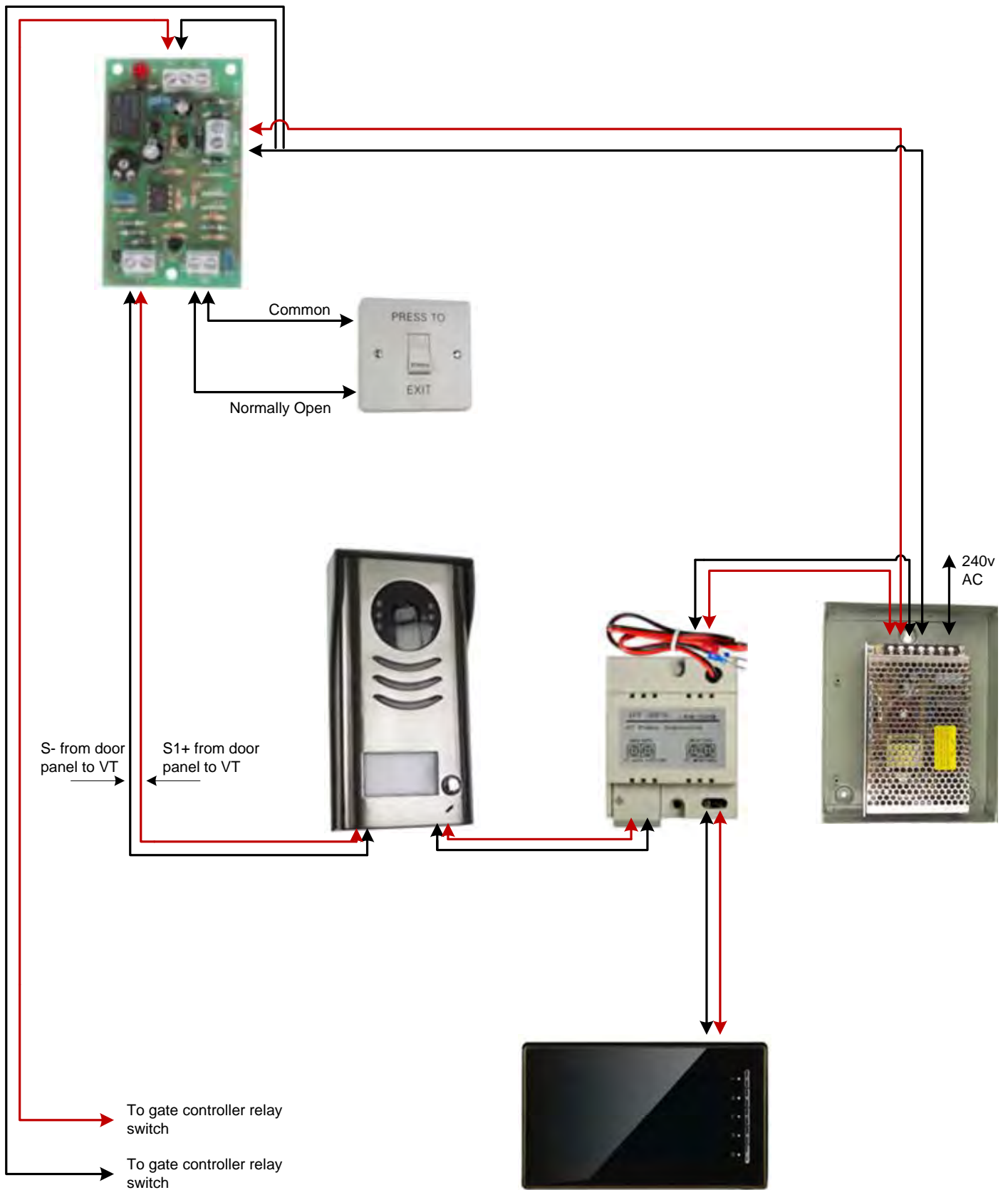

connect one lock

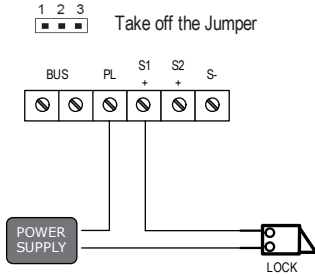

connect two locks

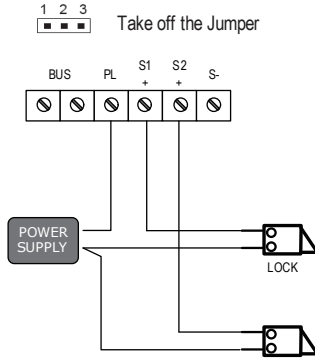

Unlock parameter setting(set on monitor)

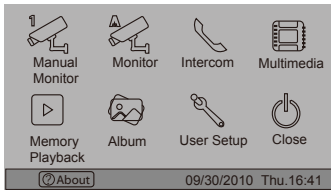

1. Touch **i** About item on main menu page.



2. Touch the screen anywhere and hold for 2s.

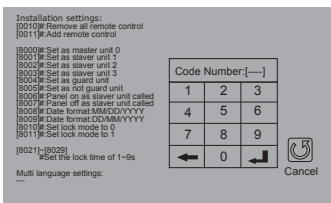

4. A digital keypad and setting instructions will be showed.

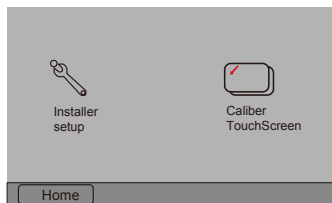

3. Touch Installer setup item

Note:

1. must connect DT596(F)/ID correctly before setting.
2. the parameter will be saved in DT596(F)/ID automatically, so you need only set on one monitor.
3. the above diagram is fit for icon menu series monitors only, to text menu series monitors, please refer to the corresponding user manual.

5.DIP Switches Setting

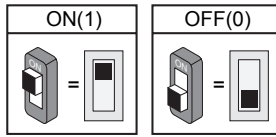

DIP Switches Settings of Door Station



Total 4 bits on the DIP switches can be configured. The switches can be modified either before or after installation.

Setting Item	Bit state	Descriptions
Bit1 and Bit2 (it is used to set the ID code for door station)		Default setting, ID = 0(00), set to the first Door Station.
		ID = 1(10), set to the second Door Station.
		ID = 2(01), set to the third Door Station.
		ID = 3(11), set to the fourth Door Station.
Bit3		The relay 2 doesn't respond the second lock, showing user cards controlled two locks or pressing unlock 2nd on monitor can not release the second lock. During this time, after continuously showing access card 10 times, the relay 2 will be closed for 60 seconds, the blue LED-relay 2 will be illuminated for 60 seconds, and the buzzer will continuously sound. If the system is connected alarm, the alarm function will be activated.
		The relay 2 responds the second lock.
Bit4		Used to authorize master card

















DIP Switches Settings of Monitor

There are 6 bit switches in total. The DIP switches are used to configure the user code for each Monitor.

Bit-6 is used to match the video impedance, which have to be set to on if the monitor is in the end of the bus, otherwise set to off.

Bit state	Setting	Bit state	Setting
	The monitor is not at the end of the bus.		The monitor is at the end of the bus.

Bit-1 to Bit-5 are used to User Code setting. The DT596(F)/ID responds to 0~15 .

Bit state	User Code	Bit state	User Code	Bit state	User Code
	Code=0		Code=6		Code=11
	Code=1		Code=7		Code=12
	Code=2		Code=8		Code=13
	Code=3		Code=9		Code=14
	Code=4		Code=10		Code=15
	Code=5				

6. ID Card Registration

Introduction:

- Up to 1000 user cards can be registered by the door station.
- Easy management with LED status and sound hints.
- There are two master cards, one MASTER CARD ADD card and one MASTER CARD DELETE card, When registered new master cards, the old master cards are invalid automatically.
- Card reading distance is from 3 to 5 cm.
- The master cards are necessary when you add or delete user cards. Please keep it well for future use.



Add User Cards:

1. Control one lock (the first lock)

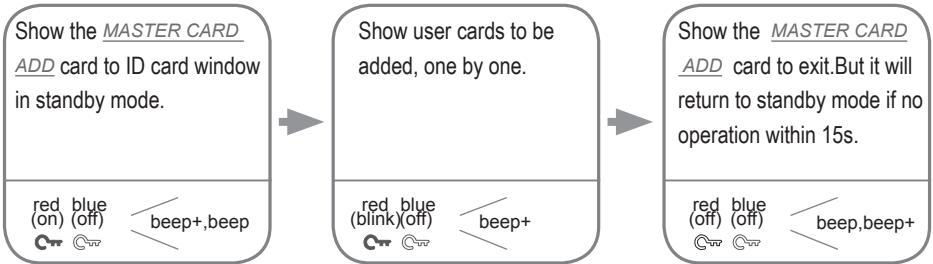

2. Control two locks

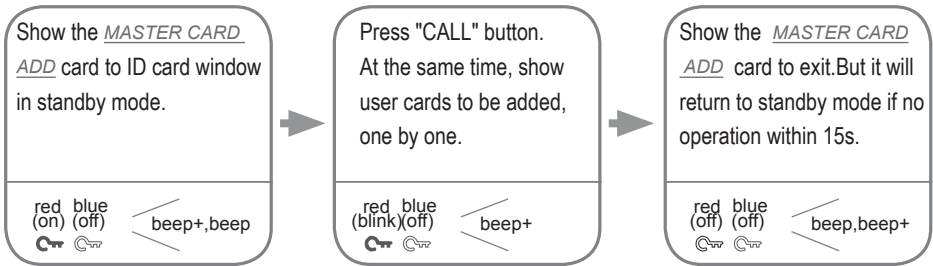

Delete User Cards:

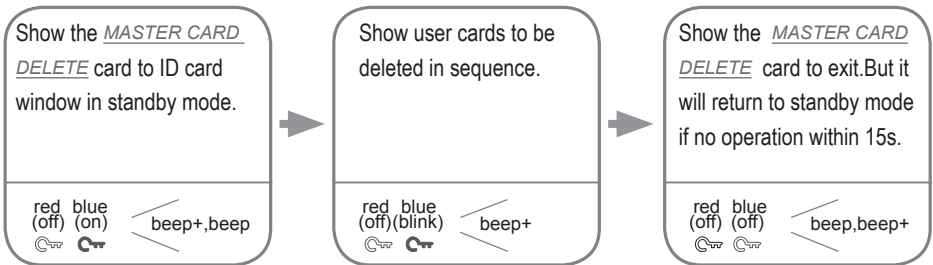

Access Initialization (delete all user cards):

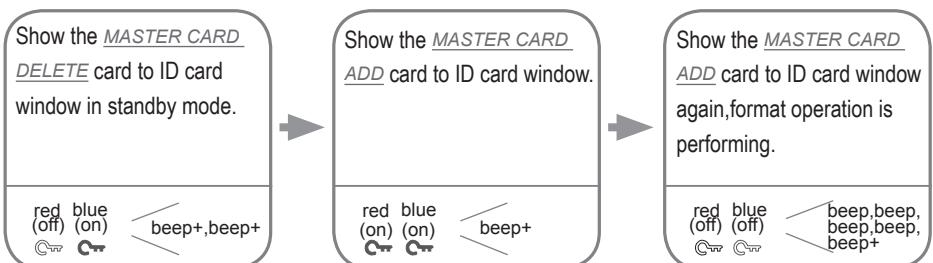

Authorize master cards:

By default,there are two master cards marked *MASTER CARD ADD* and *MASTER CARD DELETE* ,but you should know that the master card can be authorized by users at any time.That means any two user cards can be authorized to master cards,When registered new master cards, the old master cards are invalid automatically.

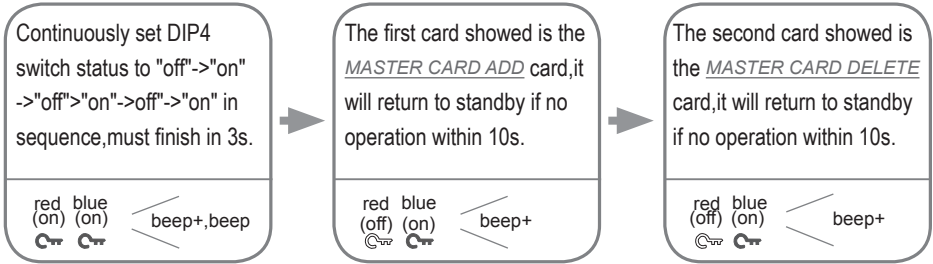

7.Unlock Operations

Unlocking of ID Card

When the registered user card has been shown to ID card window, the LED indicator (the first lock:red; the second lock:blue) lights up, the buzzer sounds,and the electric door strike is unlocked.

Note1:if the user card control one lock only,show the user card to release the first lock.red indicator lights up.

Note2:if the user card control two locks,show the user card to ID card window in standby mode,the red&blue indicator blink for 1.5s alternately.During this time,press "CALL" button to release the second lock. Otherwise,release the first lock if there isn't any operation within 1.5 seconds.

Example:release the first lock

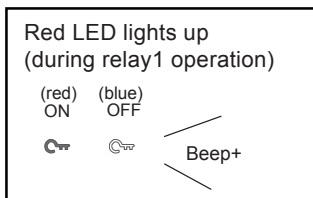

Example:release the second lock

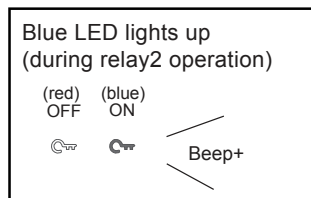

- If 10 times unauthorized access cards are continuously attempted, the release function is forbidden and the showing card operation is disabled for 60 seconds.
- When DIP3 switch is set to 1,the relay 2 doesn't respond the second lock,that's to say,showing user cards controlled two locks or pressing unlock 2nd on monitor can not release the second lock.During this time,After continuously showing access card 10 times,the relay 2 will be closed for 60 seconds,the blue LED-relay 2 will be illuminated for 60 seconds,and the buzzer will continuously sound about 8 times.If the system is connected alarm,the alarm function will be activated.

- You can activate the electric door strike by pressing the request to exit button connected to the unit. Pressing request to exit button 1 releases relay 1, and pressing request to exit button 2 releases relay 2.(The unlock function will work when the request to exit button is pushed, even while the proximity access is forbidden.



1. If show the authorized user card,the buzzer will sound of beep+,and the LED indicator will light up.
2. If show the unauthorized user card,the buzzer will sound of beep,beep,beep.

8. Precautions

- Please clean the unit with soft cotton cloth, don't use the organic impregnant or chemical clean agent. If necessary, please use a little pure water or dilute soap water to clean the dust.
- The unit is weather resistant. However do not spray high pressure water on access control keypad directly. Excessive moisture may cause problems with the unit.
- You must use the right adaptor which is supplied by the manufacture or approved by the manufacture..
- Pay attention to the high voltage inside the products, please refer service only to a trained and qualified professional.

9. Specifications

- | | |
|-----------------------------|--|
| • Power Supply : | DC 24V (supplied by PS4-24V or PS5-24V); |
| • Power Consumption: | Standby 60mA; Working status 200mA; |
| • Camera: | Pinhole Sharp Color CCD; 420 TV Lines; |
| • Lock Power supply: | 12Vdc, 300mA(Internal Power); |
| • Number of relay circuits: | 2 |
| • Mounting: | Surface mounting(DT596/ID)
Flush mounting (DT596F/ID) |
| • Working temperature: | -10°C ~ +45°C |
| • Wiring: | 2 wires,non-polarity |
| • Dimension: | 176(H)×90(W)×28(D)mm(DT596/ID)
220(H)×119(W)×52(D)mm(DT596F/ID) |

10. Cables Requirements

The maximum distance of the wiring is limited in the DT system. Using different cables may also affect the maximum distance which the system can reach.

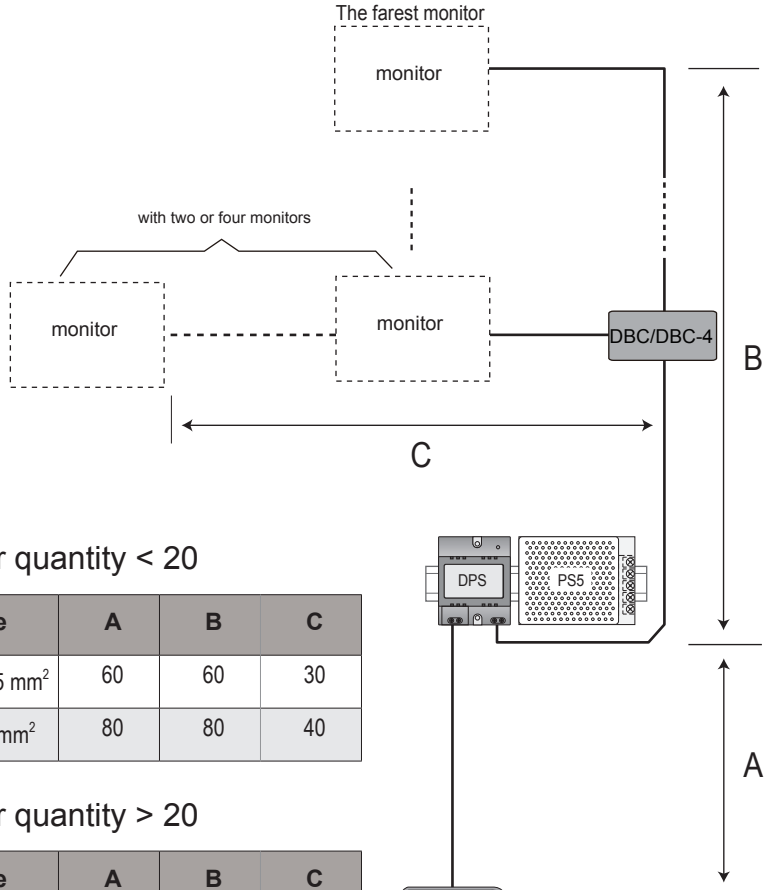

When Monitor quantity < 20

Cable Usage	A	B	C
Twisted cable 2x0.75 mm ²	60	60	30
Twisted cable 2x1 mm ²	80	80	40

When Monitor quantity > 20

Cable Usage	A	B	C
Twisted cable 2x1 mm ²	70	30	20
Twisted cable 2x1.5 mm ²	70	50	30

Note: If the monitor has been specified the distance, refer to the parameter.



2 WIRE VIDEO MONITOR

USER MANUAL

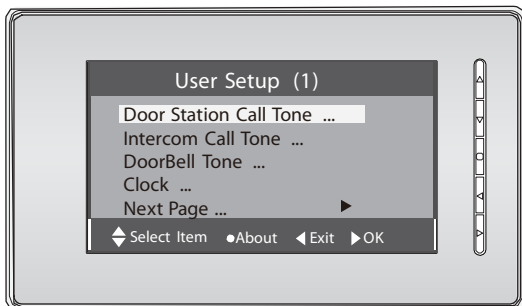

1. Parts and Functions

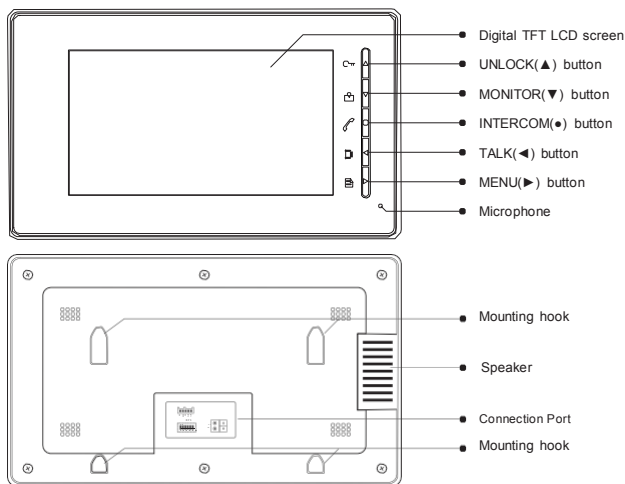

2. Monitor Mounting

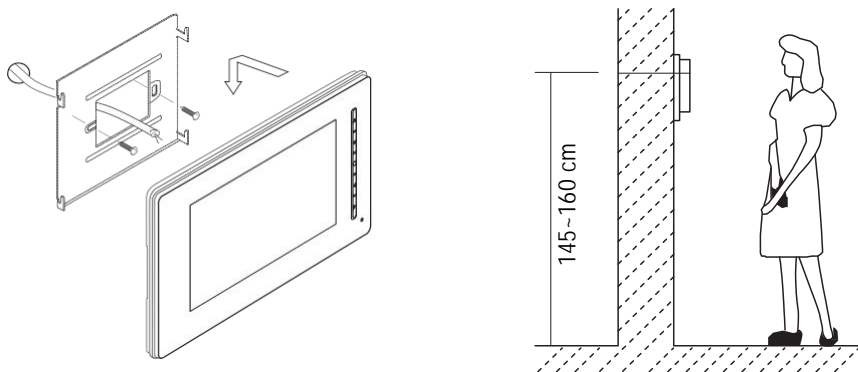

1. Use the screws to fix the Mounting Bracket on the mounting box.(fitting accessories includes a Bracket (Two pieces of 4X25 screws are needed for fastening the Mounting Bracket), Special 2 wire cables to connect with Monitor)
2. Wire the system correctly(see the later connection chapter) then hang the Monitor on the Mounting Bracket firmly.

3. Basic Door Release Operation

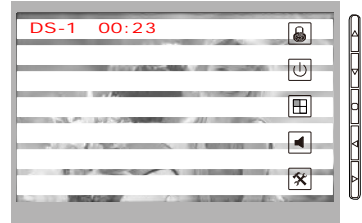

1. Press **CALL** button on outdoor station, the Monitor rings, at the same time, the screen displays the visitor image.
2. Press **TALK** (◀) button on monitor, you can communicate hands free with the visitor for 90 seconds. After finishing communication, press "TALK" button again to end the communication. If nobody answers the phone, the screen will be turned off automatically after 30 seconds.
3. During talking state, Press **UNLOCK** (▲) button to open the door for the visitor. If two locks are connected to door camera, press corresponding unlock button to open the matching door.
4. When the monitor is in standby mode, press **MONITOR** (▼), the screen can display the view of outside. If multi door stations are installed, press **INTERCOM** (●) button to enter camera switch mode. Select **Camera 1 ...** item, the screen will display the image from the first door camera. Similarly. Select **Camera 2 ...** item to choose the second one. Select **Camera 3 ...** item to choose the third one. Select **Camera 4 ...** item to choose the fourth one. (Press "MONITOR" button again to end monitoring.)

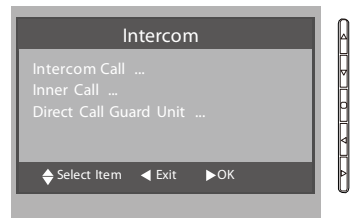

4. Intercom Function

When the monitor is in standby mode, press **INTERCOM** (●) button to enter Intercom Function page. Use ▲ / ▼ button to move upward / downward to select the item you want, press **MENU** (▶) button to confirm.



other apartments in the system. the namelist will be created automatically by the system. Select a name on the screen then press  MENU () button to





2.The DIP switches code of each monitor must set different.)

Inner Call: If multi Monitors are installed in the same apartment, select Inner Call, all the other Monitors will ring at the same time, whichever Monitor answers the call, conversation is started.and the other monitors will stop ringing at the same time.(note:the DIP switches setting of all monitors must be same.)

Direct Dial Guard unit: A Monitor can be assigned as Guard Unit Monitor; when the Guard Unit Monitor answers the call, conversation with the guard person is started..

5. Basic Setup Instructions

Ring Tone Settings

Select **Door Station Call Tone**, **Intercom Call Tone** or **DoorBell Tone** item on User Setup (1) page, There are 12 pieces ring tones can be selected.use ▼ /▲ Button to select last/next ring tone, press  MENU () button to save and exit.

Door Station Call Tone :set the ring tone calling from outdoor station.

Intercom Tone :set the ring tone calling from other apartments.

DoorBell tone :set the ring tone calling from door bell.

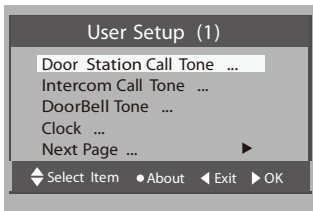

6. Date and Time Setting

Select Clock... item on User Setup (1) page. Input date and time by pressing ▲ / ▼ button to increase / decrease the value; press ◀ / ▶ button to select last/next digit. After finish, press INTERCOM (●) button to save and return last page.

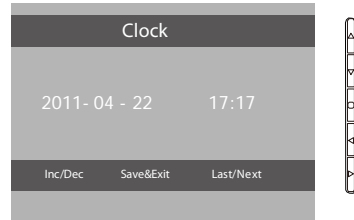

7. Monitor Time Setting

Select **Manual Monitor** item on main menu page, then select Monitor Time Set... item. Use ▲ / ▼ Button to increase / decrease the value; After finish, press INTERCOM (●) button to save and return last page.

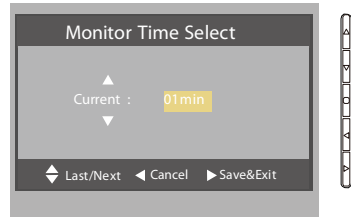

8. Monitor Installation Setting

How to enter the installation setting page

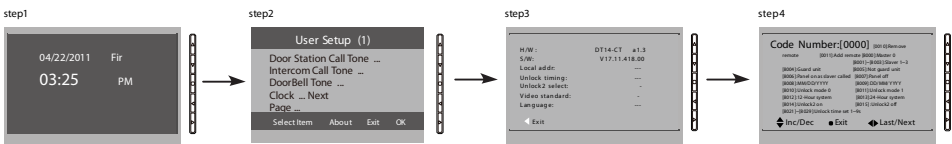

1. Press MENU (▶) button in standby mode. A calendar will be showed, then press MENU button again.
2. Press INTERCOM (●) button at User Setup (1) page to enter About information page.
3. Press UNLOCK (▲) button and hold for 2s.
4. Press ▲ / ▼ button to increase/decrease the value and ◀ / ▶ button to select the setting number, press MENU (▶) to save the settings after inputing 4 digits number, press ● button to return last page.

How to set the monitor panel on

In default mode,when receive a calling,the master and slave monitors will ring at the same time,and just the master monitor can display the image while the slave monitors can not.But the settings can be changed,you can set the master monitor and all the slave monitors to panel on at the same time when receiving a call, just input the code number of 8006 on each slave monitor.

How to set the unlock parameter

Unlock mode:

There are two unlock modes: 1.power-on- to-unlock type:unlock mode=0(by default)
2.power-off-to-unlock:unlock mode=1.

The code number of 8010 is used to set the unlock mode to 0

The code number of 8011 is used to set the unlock mode to 1

Unlock time:

The unlock time can be changed by yourself at any time.it can be set from 1 to 9 seconds.

The code number from 8021 to 8029 are used to set the unlock time to 1~ 9 seconds.

2 locks control

The monitor can be set to control 2 locks while you should set the unlock2 item to "on " state.

The code number of 8015 is used to set the unlock2 off that it can only control one lock.

The code number of 8014 is used to set the unlock2 on that it can control two locks.

Note:1. During talking or monitoring state, press $\text{C}\overline{\text{T}}$ UNLOCK (▲) button,two unlock icons will be showed. press $\text{C}\overline{\text{T}}$ UNLOCK (▲) button to release the first lock, press $\text{C}\overline{\text{T}}$ UNLOCK (▲) button to release the second lock,press M MONITOR (▼) to return last page.

2. Restore to default operation will not chang the parameters setting.

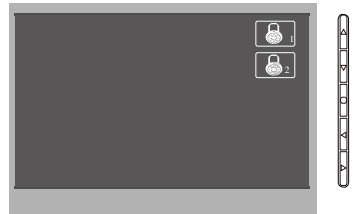

How to set the menu language

The monitor can support multi languages and it is so simple and fast, just input the corresponding language code on monitor. The language code number are as follows:

8101: English	8107: Portuguese	8113: Russian
8102: French	8108: S-Chinese	8114: Slovakia
8103: Spanish	8109: T-Chinese	8115: Hungray
8104: Italian	8110: Greek	8116: Czech
8105: German	8111: Turkish	
8106: Dutch	8112: Polish	

Note: the monitor can only support 4 types of languages. English, French, Spanish and German are default. But you can customize any 4 languages by yourself. The language which is unavailable will be set to English in default.

9. Screen and Volume Adjustment

During monitoring or talking, press MENU Button, the ADJUST MENU will be displayed.

Press ▲ / ▼ button to select the adjustment item; press ◀ / ▶ button to decrease / increase the value.

1. The first item is Scene mode selection: Total 4 screen modes can be selected in sequence: Normal, User, Soft and Bright. Whenever you modify Brightness or colour, Scene item will be set to User mode automatically.
2. The Brightness and Colour item is for the image quality setting, adjust the value to get the best image you like.
3. The Ring Volume and Talk Volume items are ring tone and talking volume adjustment.
4. Note that all the modifications will be done immediately after the operation. Press "MENU" button to quit the adjust page.

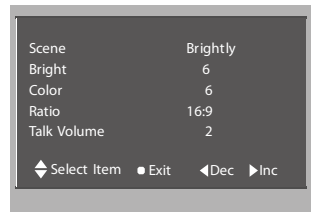

Additional Monitor Connections

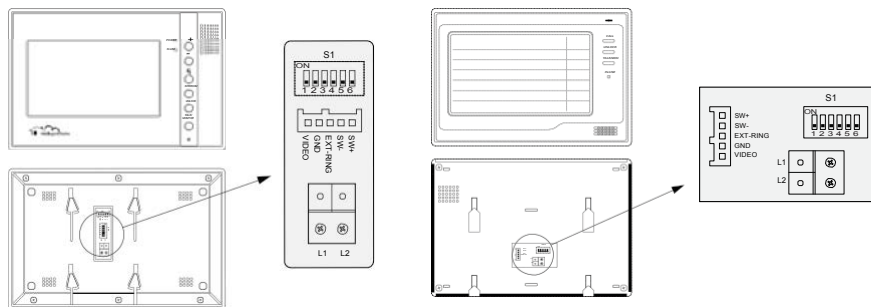

1. Door Bell Call Button

Additional door bell call button can be connected to the Monitor, so that the visitors can ring the door bell again in front of the user's apartment. When the call button is pressed, the Monitor will output ring tones but the screen will keep off, and the external ringer will ring at the same time (if an external ringer is installed).

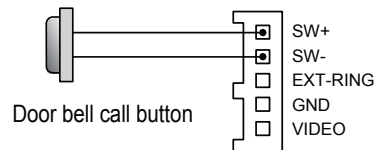

2. External Ringer

External ringer can be connected to the Monitor. The ringer will ring whenever the Door Station call button or the door bell call button is pressed, and it will stop ringing when the Monitor rejects or answers the call.

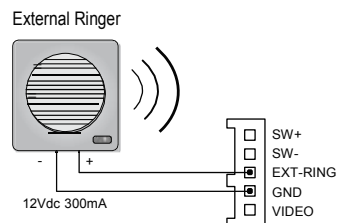

3. TV-out function

Connect television to the Monitor, when the Door Station calls, the user switch the channel to the AV channel, and the visitor's video will show up on the screen of the television. The core of the video cable must connect to the VD terminal, and the shielded layer connect to the GND.

