

10001 series Mini Electromagnetic Lock



Features

- High reliability
- Aluminum anodized casing
- MOV provides spike and surge protection
- Dual voltage 12 or 24 VDC (selectable)
- Single voltage only 12 VDC (10002BZ)
- Anti-Residual magnetism function

Statement

10001 series are designed for surface mount on out-swing doors. The maglocks can be configured to mount on in-swing and glass doors with optional LZ- and U-shaped brackets. Other optional operation features include magnetic bond sensor, relock time delay, door status monitor, and buzzer alarm.

Specification

- Operating voltage: Dual voltage: 12/24 VDC
Single voltage: 12 VDC (10002BZ)
 - Current draw: 500mA/12VDC; 250mA/24VDC (at temperature 20°C)
 - Operating temperature: -10~55°C(14~131°F)
 - Humidity: 0~95% non-condensing.
 - Holding force: Up to 600 lbs(272 Kg)
 - Dimensions:
 - Magnet:(L) 250, (W) 42, (D) 26 mm
 - Armature plate:(L) 185, (W) 38, (D) 12 mm
 - Mounting plate:(L) 250, (W) 25, (D) 5 mm
 - Special finishes for magnet and armature plate: Zinc plated
 - Epoxy potting compound : E87252 (S), UL94V-0
 - Net Weight: 2.0 Kg
- * 10002BZ: (L)288,(W)42,(D)26mm

Regular Installation

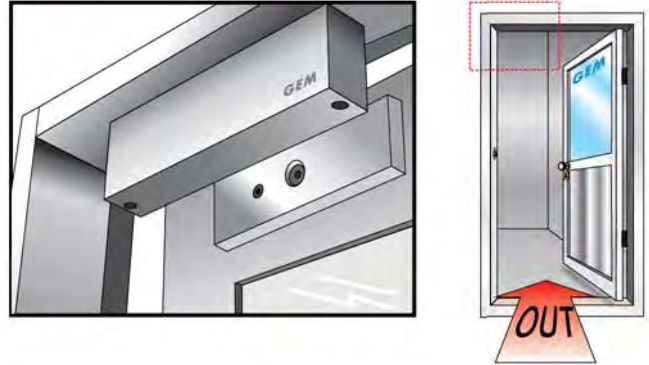

Anti-residual statement

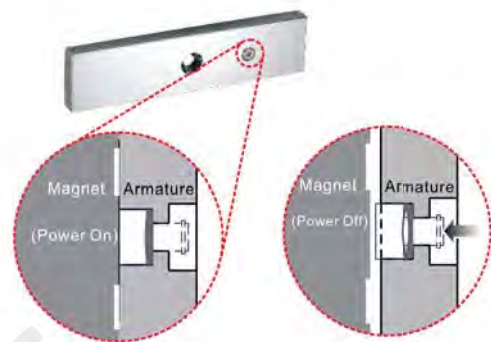

Anti-residual statement

Our electromagnet locks feature Anti-Residual Magnetism (ARM) which ensures the door can be opened without any resistance from left over magnetism imparted to the armature plate

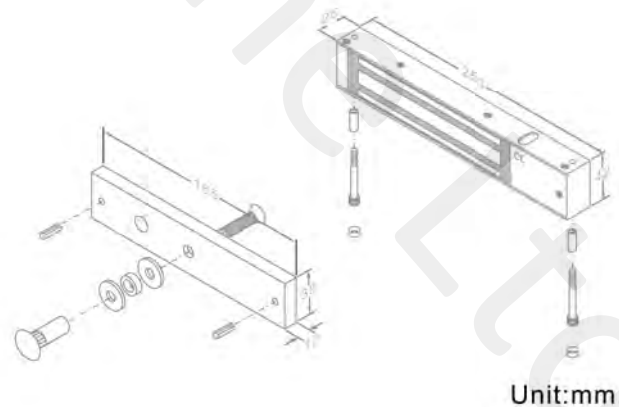

Unit:mm

Operating Features



10002: Bond sensor output

Indicate the locked & unlocked status with visible LED indicator.

Bond sensor output : SPDT rated: 0.5A/125VAC;1A/24VDC



10002BZ: Buzzer Alarm

Door Held Open Alarm is an auditory feedback for users. The alarm sounds when the door is not closed and that has exceeded a specified time limit. VR timer is adjustable from 1 to 80 seconds.



10002DS: Door status

Door Status Sensor indicates the door is in an open or closed status.

Door status output : SPDT rated: 0.2A/12VDC

Trigger



Timer Adjust



1 to 80 seconds

10002TD: Relock time delay

Ensure automatic locking after the door is closed properly. Relock time delay can be adjusted from 1 to 80 seconds.

Optional Brackets

Bracket installation is according to door swing direction and door frame type , e.g. narrow frame door , frameless glass door , inswing door , etc.

U-bracket for frameless glass doors
UBK-013 for 10~12mm glass thickness

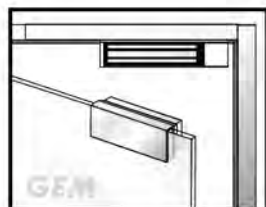

L-bracket for narrow door frames

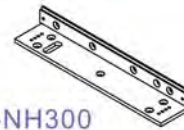

L-NH300

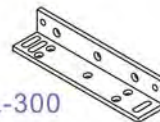
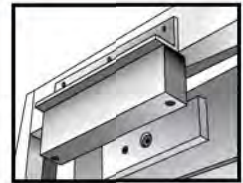

L-300

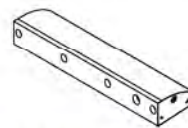
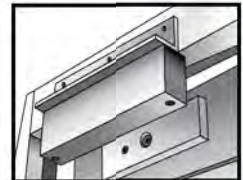

EM-10001L

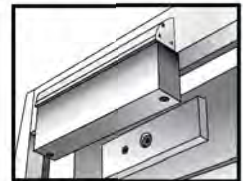

L-300BZ
(For 10002BZ)

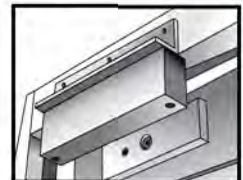

LZ-bracket for in-swing doors

LZ-NH300N

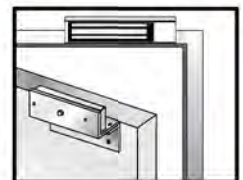

LZ-300N

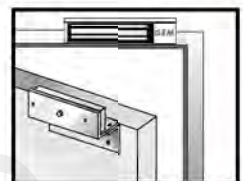

EM-10001LZ

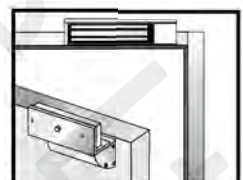
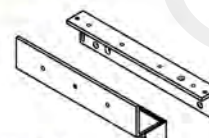

LZ-300BZ
(For 10002BZ)

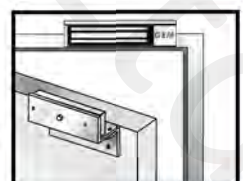
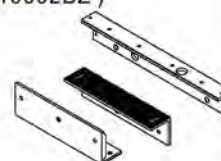

10001 series Mini Electromagnetic Lock

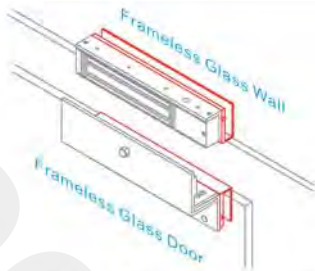

UBK-300-2 and UBK-300-3 brackets are compatible with LZ-300 brackets for 10001 series of electromagnetic locks. These brackets allow for installation on 10 ~ 13 mm thickness of in-swing glass doors and frames. (Except 10002BZ)

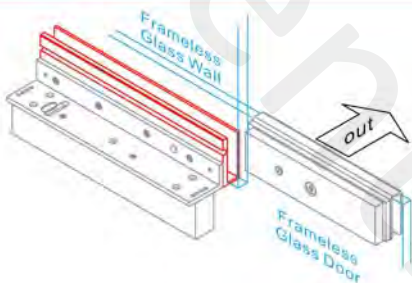
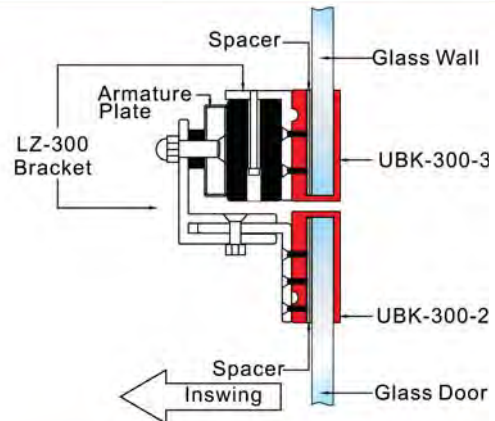

UBK-300-1 bracket is compatible with L-300 and UBK-013 for 10001 series of electromagnetic locks. The bracket allows for installation on 10 ~ 13 mm thickness of out-swing glass doors and frames. (Except 10002BZ)

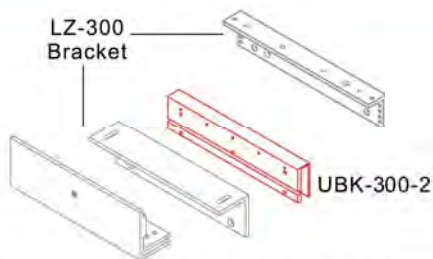
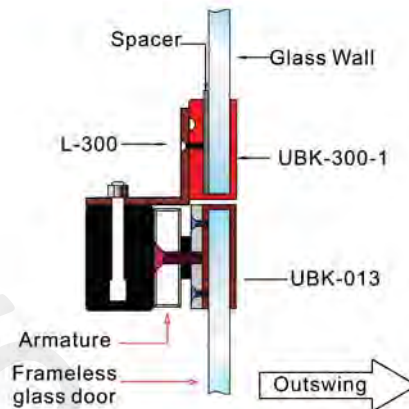

UBK-300-2 brackets are compatible with LZ-300 brackets for 10001 series of electromagnetic locks. These brackets allow for installation on 10 ~ 13 mm thickness of in-swing glass doors. (Except 10002BZ)

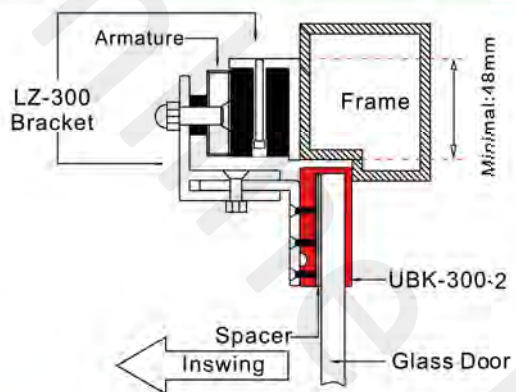

Electromagnetic Lock Installation Instruction (Indoor Series)

Optional Bracket

Bracket installation is according to door swing direction and door frame type, e.g. narrow frame door, frameless glass door, inswing door, etc.

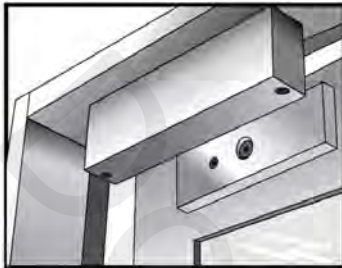

Regular Installation
(outswing door)

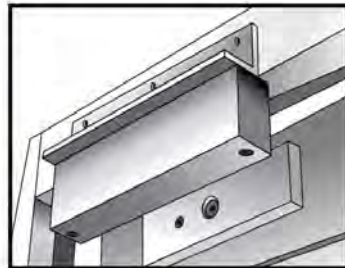

L-bracket for narrow
frame (optional)

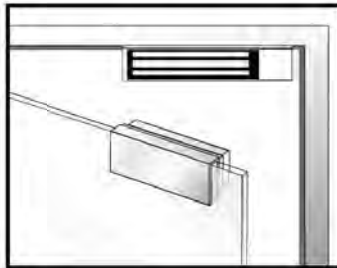

U-bracket for frameless
glass door (optional)

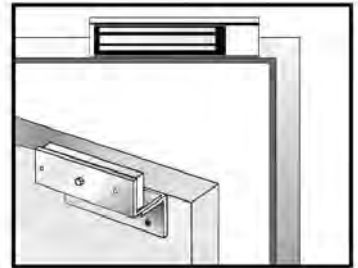

LZ-bracket for inswing
door (optional)

Regular Installation

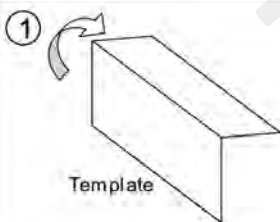

Fold the mounting template 90°

Template

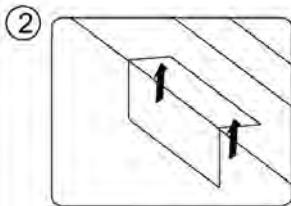

Place the template to the proper position of the door and frame. Mark the hole positions of the template on the door and frame.

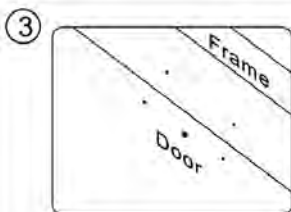

Drill the holes according to the marks.

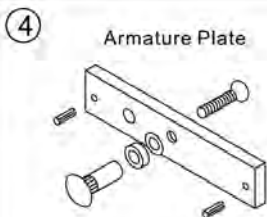

Please install the armature plate as illustrated here. (Dimensions of the holes are depending on the door types as illustrated below.)

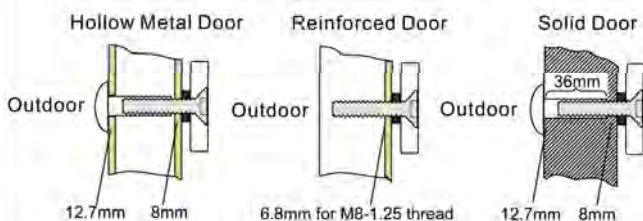

Drill a $\varnothing 8\text{mm}$ hole through door, on closing side enlarge to $\varnothing 12.7\text{mm}$ by a sexnut blot on the opening side.

Drill a $\varnothing 6.8\text{mm}$ hole and tap on closing side a M8x12.5 thread.

Drill a $\varnothing 8\text{mm}$ hole through door on closing side enlarge to $\varnothing 12.7\text{mm}$, by a sexnut blot on the opening side. The depth is 36mm.

Recommendation:

For Micro EM-locks (300 LBS), maximum thickness of door is 44 mm.

For Mini EM-locks (600 LBS), maximum thickness of door is 50 mm.

For Midi EM-locks (800 LBS), maximum thickness of door is 48 mm.

For Maxi EM-locks (1200 LBS), maximum thickness of door is 46 mm.

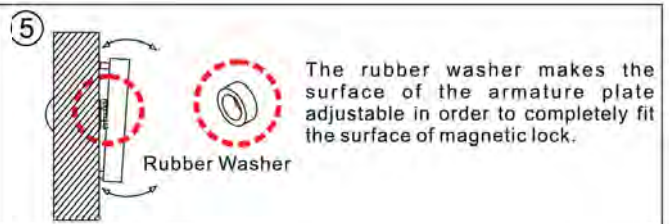

The rubber washer makes the surface of the armature plate adjustable in order to completely fit the surface of magnetic lock.

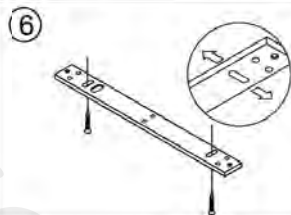

Fasten the mounting plate with the mounting screws. The position of the mounting plate should be adjustable.

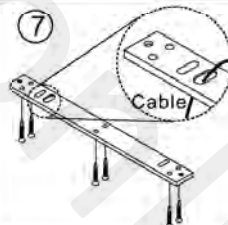

Fix the mounting plate on the door with mounting screws

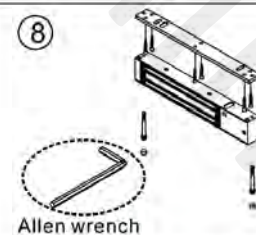

Use the Allen wrench and fixing bolts to tighten the electromagnetic lock to mounting plate.

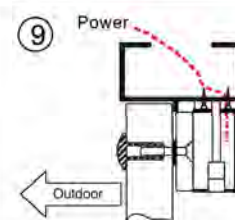

Connect the power and test the unit.

LZ bracket for Inswing doors

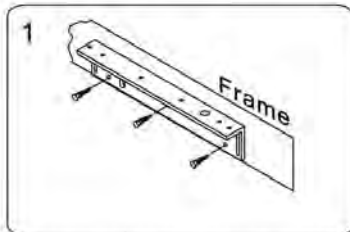

Find a mounting location on the door frame for the L bracket. Make sure that the door is still closeable.

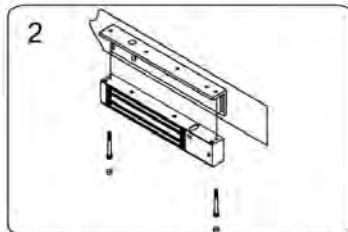

Use the fixing bolt to tighten the electromagnetic lock on L bracket.

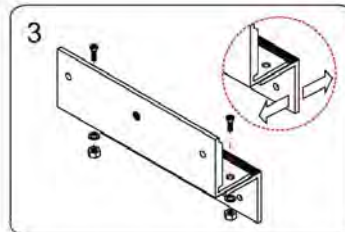

Assemble the Z bracket, and make sure that the position of the Z bracket is adjustable.

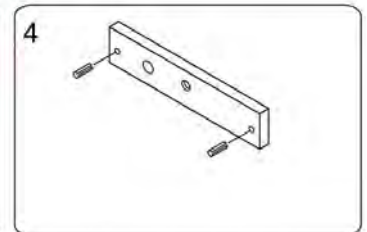

Insert the guide pins into the armature plate.

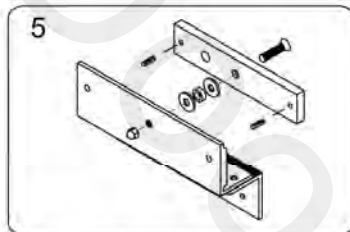

Fasten the armature plate to the Z bracket (Rubber washer must be added)

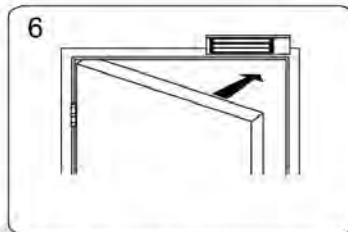

Close the door and connect the power.

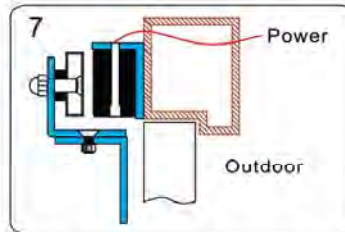

After the maglock attracts the armature plate, adjust the position between Z bracket and the door. Then fix the Z bracket.

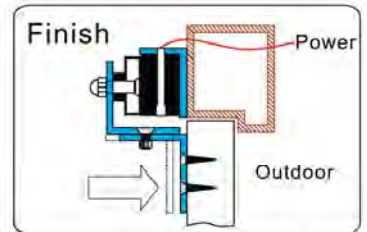

Connect the power, close the door and test the unit.

Connecting Diagram

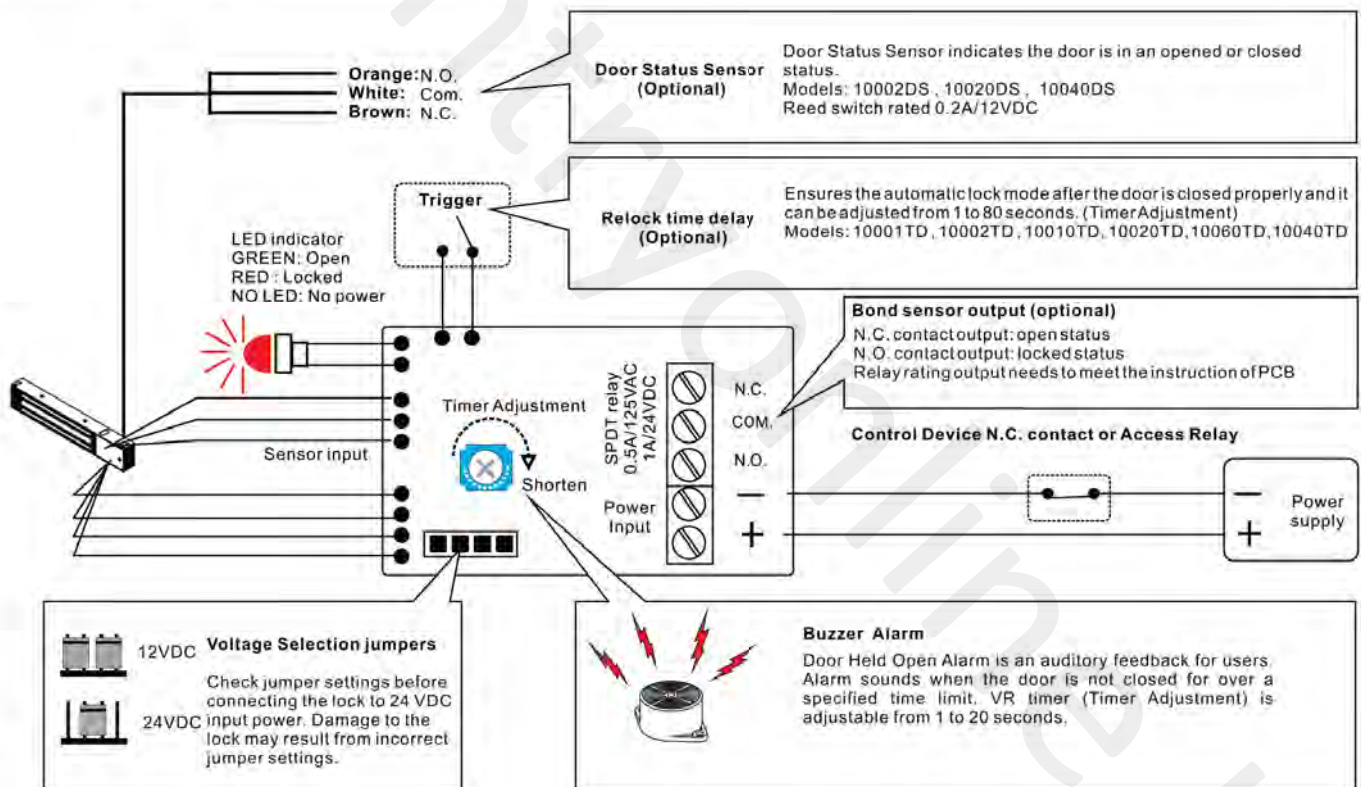

Trouble Shooting

Problem	Possible Cause	Solution
Door does not lock	No power	Make sure the wires are connected properly Check that the power supply is connected and works properly Make sure the lock switch is wired correctly (N.C.)
Low holding force	Poor contact between electromagnet and armature plate	Make sure if the armature plate is deformed Make sure if the rubber washer was used between the bracket lock and armature plate Make sure the contact surfaces of the electromagnet and armature plate are clean and free from dust
	Low voltage or incorrect voltage setting	Check the electromagnet lock is set for the correct voltage. Check the voltage at the of input electromagnetic locks. If low, determine if the correct wire gauge is being used to prevent excessive voltage drop.
Sensor output is not functioning	A secondary diode was installed across the electromagnetic lock	Remove any diode installed across the magnet for "spike" suppression. (The magnet is fitted with a metal oxide varistor to prevent back EMF)
	Misalignment between the armature plate and electromagnetic lock	Make sure the armature plate and electromagnetic lock are aligned correctly