

# Access control system with lock release

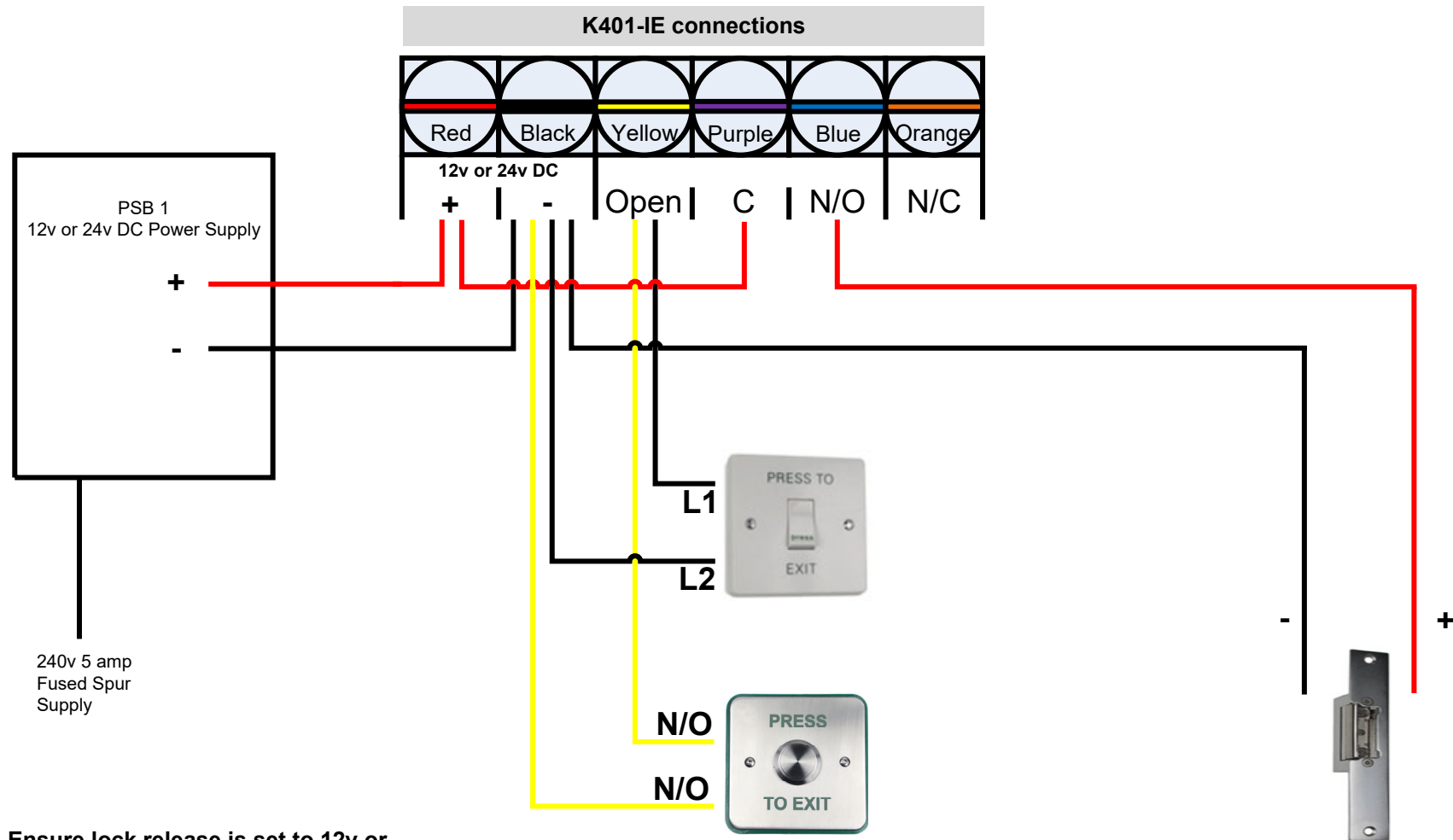

Ensure lock release is set to 12v or 24v dc operation before testing

# Access control system with magnetic lock

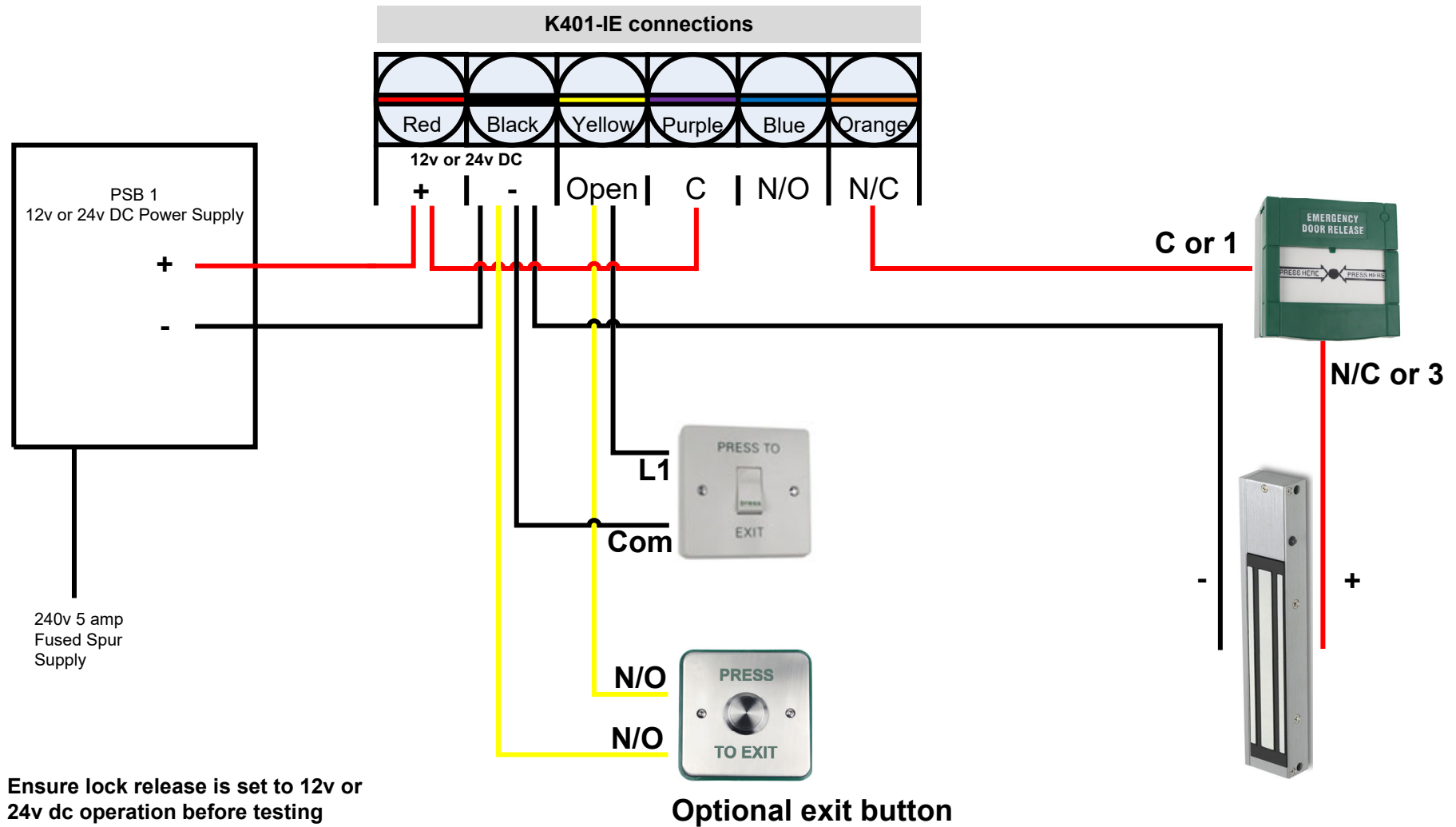

# Access control system to gate controller

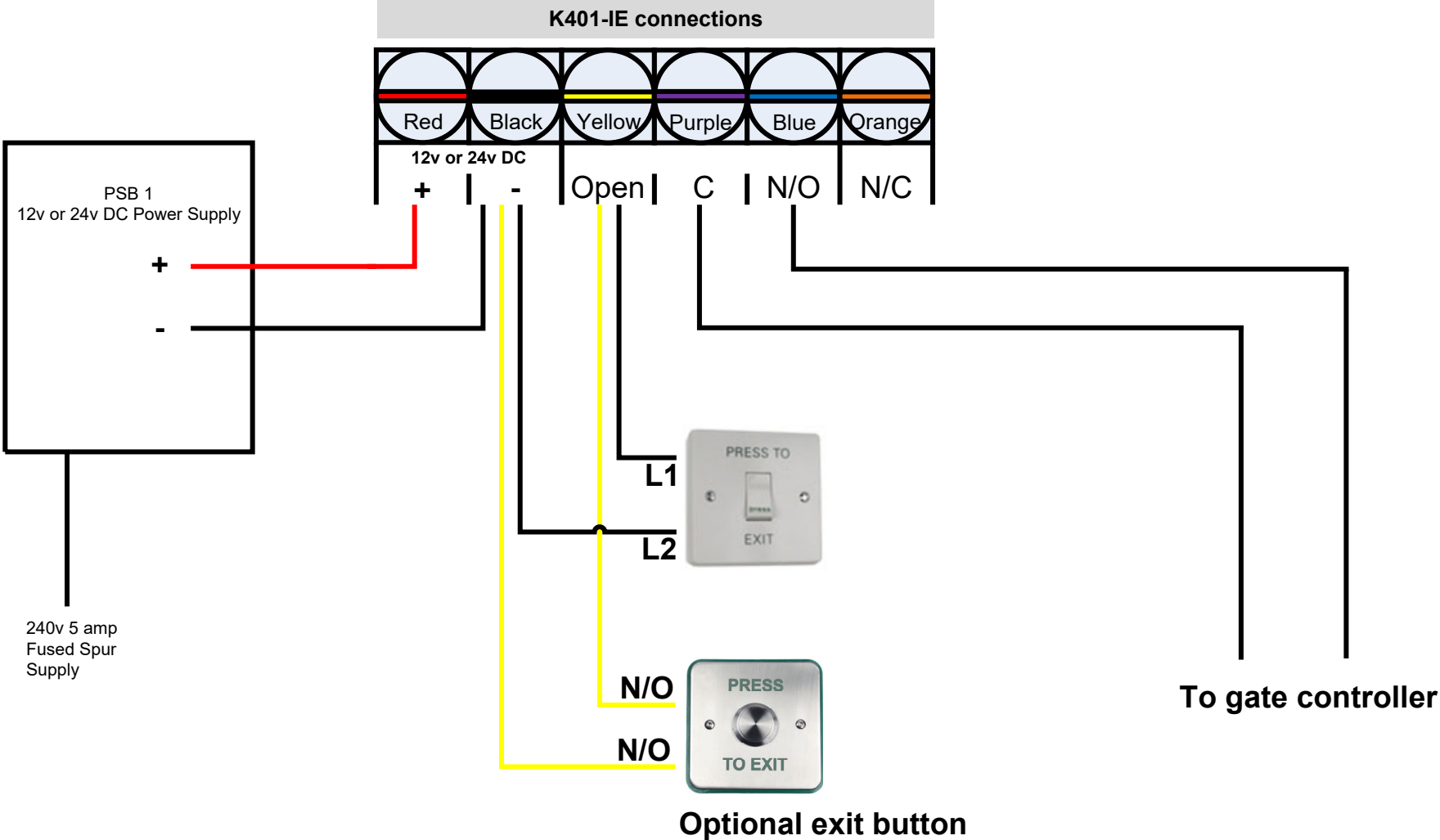

# Access control system with magnetic lock & additional reader

