

DBC4S - 4 Way branch connector

User Manual

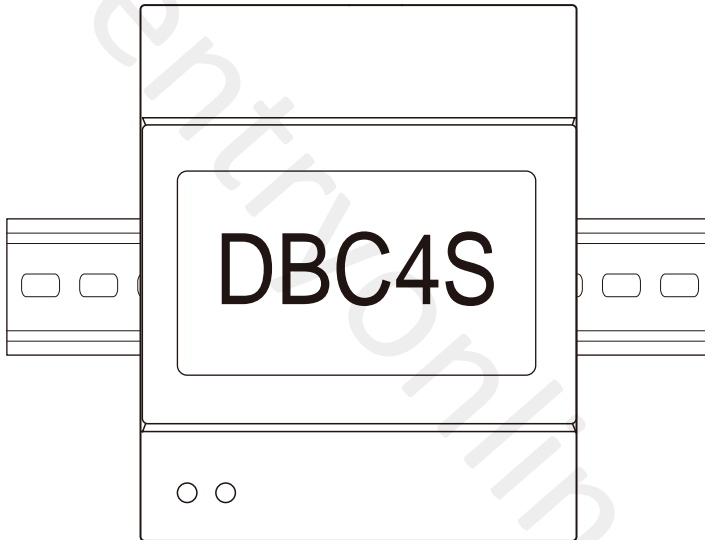

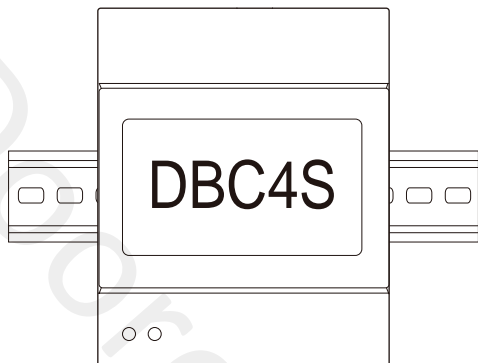

The DBC4S is a digital surface mounted 4 way branch connector/splitter that is used to distribute the audio and video signal equally between a maximum of four video monitors or four door panels - The DBC4S can be used for both

The DBC4S is **only** required when adding additional video monitors that have been installed using the typical Star Network cable layout

The DBC4S is **absolutely** required when adding additional door panels regardless of cable layout

Example 1: If you have installed cables using the "Star Network" whereby each video monitor cable is individually installed to a central location, then you would use one DBC4S for connection of up to four video monitors

Example 2: If you have installed cables using the "Star Network" whereby each video monitor cable is individually installed to a central location and you have installed an additional door panel/s, then you would use one DBC4S for connection of up to four video monitors and a separate DBC4S for up to four door panels

Example 3: If you have installed cables using the "Loop In/Out" whereby each video monitor cable is looped from one video monitor to the next video monitor and you have installed an additional door panel/s, then you would use one DBC4S for the door panels only

1. Parts and Functions

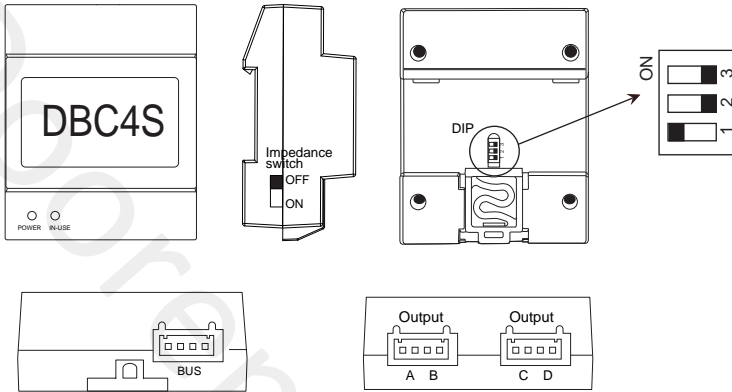

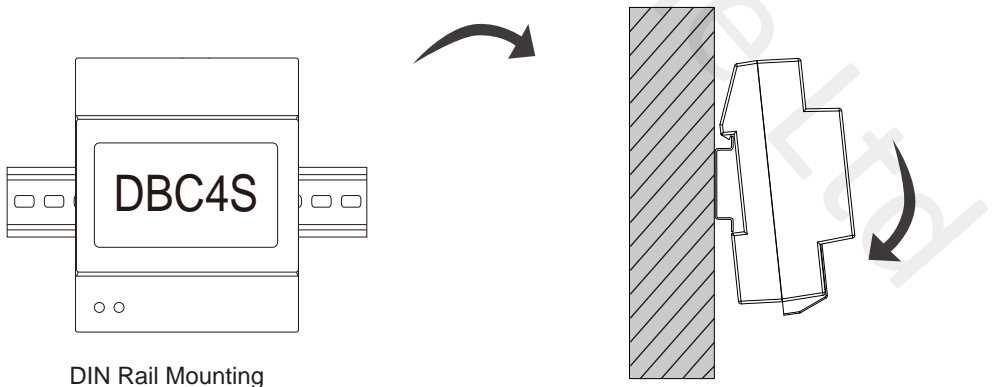

- IN-USE: Status indicator, it will light up when the unit receives a signal.
- POWER: Working indicator, it will light up when the power supply is active.
- Impedance Switch: Video match switch, the last DBC4S at the end of the bus line should be set to ON to match the video impedance, the power indicator will turn to orange after making this setting.
- Bus: Input and output bus connection port.
- A,B,C,D: Outputs for connection to video monitors or door panels.
- DIP: Used for current control when connected with different devices.

2. Unit mounting can be DIN rail or surface mount



3. DIP Switch Settings

The DIP switches on the rear of the DBC4S are used to adjust the terminal start-up current. Please refer to the following for more details about the DIP switch settings:

DIP	Bit State	Descriptions
	ON,OFF,OFF	The output ports of A,B,C,D are connected with devices such as all monitors or door panels - 591, 592, 596 & DMR3 - 8
	OFF,ON,OFF	Not applicable with Dooretryonline Ltd systems
	OFF,OFF,ON	Not applicable with Dooretryonline Ltd systems

1 x DBC4S can control a maximum of four door panels or four video monitors. Monitors and door panels cannot be mixed together. Such installations will require additional DBC4S units

4. System Wiring with DBC4S

Mult Door Panel Wiring: (Please note the DIP switch settings for each door panel)

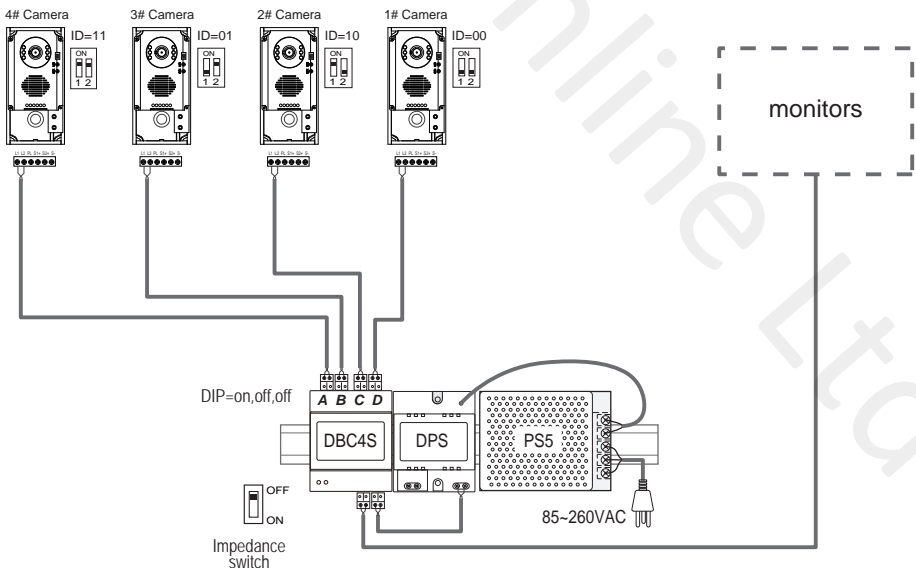

Note: the diagram uses DT591 as an example.

Multi Monitor Wiring:

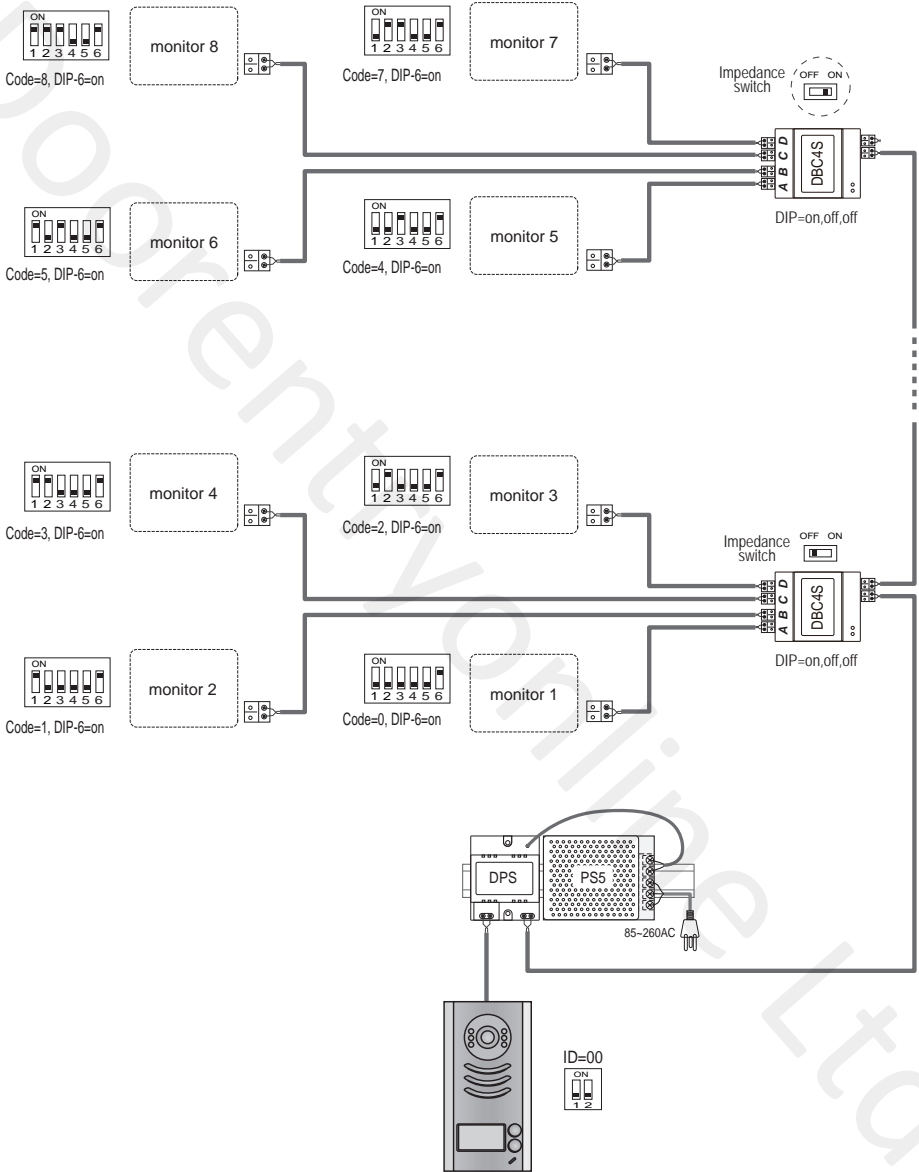

5. Specification

Power Supply :	DC 24V
Working Temperature:	-10°C~+40°C
Wiring:	2 wires (non-polarity)
Dimension:	89(H) × 70(W) × 45(D)mm

The design and specifications can be changed without notice to the user. Right to interpret and copyright of this manual are preserved.
